

Digi-Pas®

Innovation & Technology Driven™

USER MANUAL

2-AXIS



2-Axis Precision Digital Level Model: DWL2000XY

www.digipas.com

REVISION 2.00

Note: Contents in this instruction manual is continuously updated, please check Digi-Pas website for latest version.

INTELLECTUAL PROPERTY

This manual contains propriety information, which is protected by copyrights. All rights are reserved. No part of this manual may be photocopied, reproduced, redistributed or translated to another language without prior written consent of JSB TECH Company.

The information in this manual was correct at the time of printing, stored in CD or uploaded in the Company website. However, JSB TECH will continue to improve products and reserves the rights to change specification and maintenance procedures at any time without prior notice.

Digi-Pas® Products were manufactured under ISO9001 & ISO14001 standards, tested to comply by the followings certification bodies:



CONTENTS

CHAPTER 1: DEVICE OVERVIEW

- Technical Specification
- Overview
- List of Items

CHAPTER 2: SETTING UP

- Operating Procedure
- Mounting Device on Fixture

CHAPTER 3: USER INTERFACE

- Single Axis Mode Interface
- Dual Axis Mode Interface
- Main Menu Icon Functions

CHAPTER 4: FEATURES AND SETTING

- Absolute Level
- Alternate Zero
- Setting Menu

CHAPTER 5: STORAGE AND CLEANING

CHAPTER 6: WARRANTY

APPENDIX: USER CALIBRATION

CHAPTER 1: DEVICE OVERVIEW

Technical Specification

DWL2000XY

Measurement Range (Single Axis Mode)	0.00° to ± 90.00°
Measurement Range (2-Axis Mode)	0.00° to ± 3.00°
Resolution	0.01° (175µm/M) (0.002 in/ft)
Accuracy	± 0.02° at 0.00° ~ ± 2.00° (349µm/M) (0.004 in/ft) (72 arcsec.) ± 0.04° at other angle
Repeatability	0.01° (175µm/M) (0.002 in/ft)
Cross Axis Error	Negligible (± 0.0025°)
Display	Colour TFT LCD
Power Supply *	4 x AAA 1.5V Batteries / USB
Material	PC ABS / Aluminium
Connectivity	USB 2.0 Cable (≤ 5 metre)
PC SYNC Software	Professional Edition (Optional)
Operating Temperature	-10°C to +50°C (Calibrated) 14°F to 122°F (Calibrated)
Dimension (mm)	188 x 62 x 37
Nett Weight (Approx.)	580 gram
User Self Calibration	Yes

Specifications are subject to change without notice.

*Alternative Device power can be obtained from External USB Power Source.

Note:

Product performance to specification are comply with accredited Calibration & Test Providers in USA, Japan, UK and Germany and traceable to **NIST, JIS, UKAS & DIN** under the International Laboratory Accreditation Cooperation (**ILAC**) and American Association for Laboratory Accreditation (**A2LA**). For more information, please visit “www.digipas.com”.

Device Overview

Battery Compartment of 4 x "AAA" size 1.5V batteries.

-Observe the polarity of the batteries indicated on the top of the battery cover

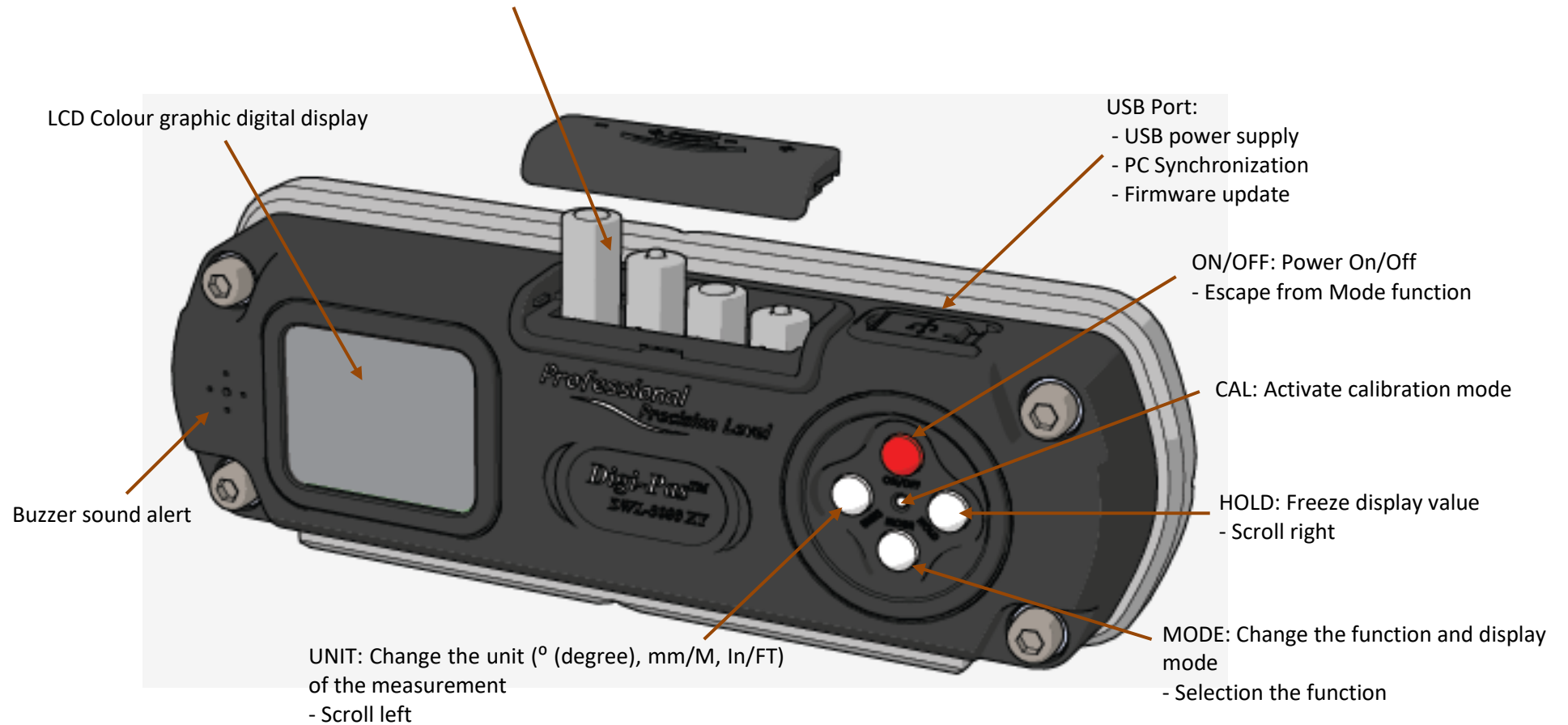

List of items included in DWL-2000XY product package

Item No.	Description	Quantity
1.	DWL 2000XY Precision Digital Level	1 unit
2.	Certificate of Calibration	1 set
3.	AAA batteries	4 pcs



CHAPTER 2: SETTING UP

Operation Procedure

1. Insert 4 pieces of "AAA" batteries into the battery compartment and press ON/OFF button. Alternatively, insert USB power source to the USB Port to power up the device. Take note that the device performance might be affected when poorly regulated USB power source is used.

Battery: 4 x "AAA" size 1.5V batteries

(Take note on the battery's polarity as indicated on top of the battery cover)

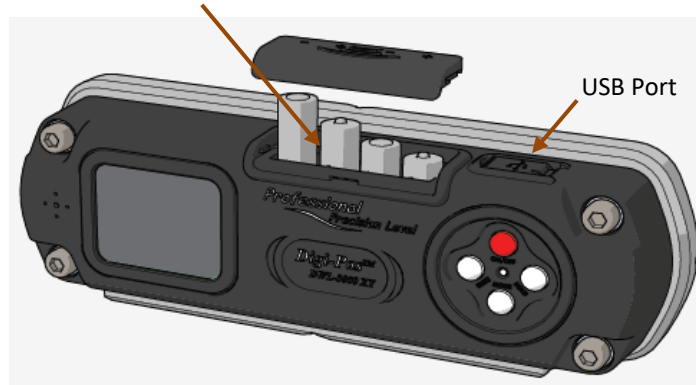

2. Allow sufficient time for device to warm up and stabilise after turning on the device.
3. Device ready to use.

Note: For maximum accuracy, perform calibration (refer to APPENDIX: User Calibration) or Absolute Level (refer to Chapter 4: Absolute Level for more details) before measurement.

Mounting Device On Fixture or Work Piece

The two threaded holes are provided for mounting the device onto user-defined fixtures/machinery.

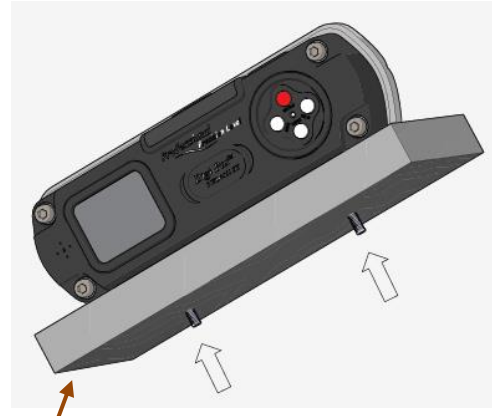
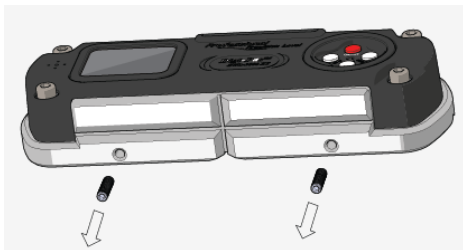

User defined fixture/machinery

To mount the device onto user's defined fixture or work piece. Remove both the set screw (M5), then replace with appropriate type of screws specified by user.

CHAPTER 3: USER INTERFACE

Single Axis Mode Interface



Single Axis Mode Display Screen and Button Function

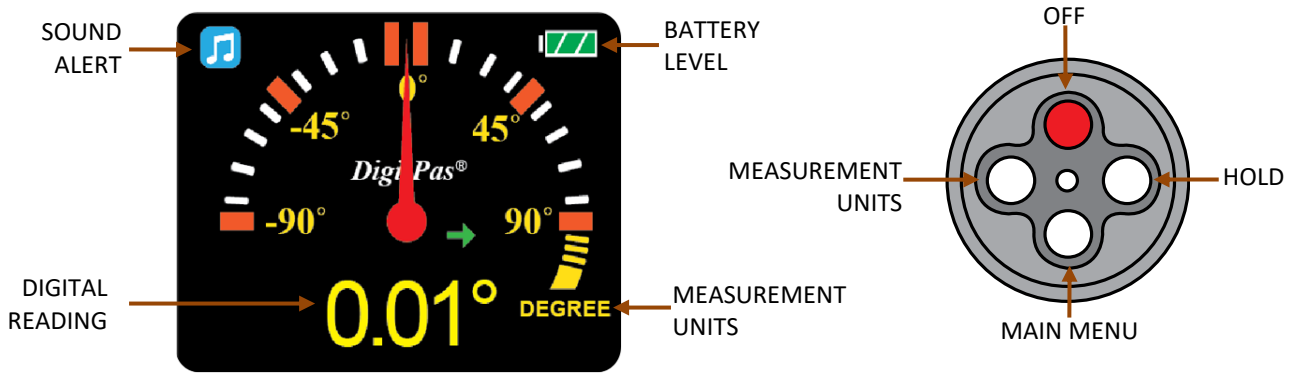

Single Axis Mode Operation

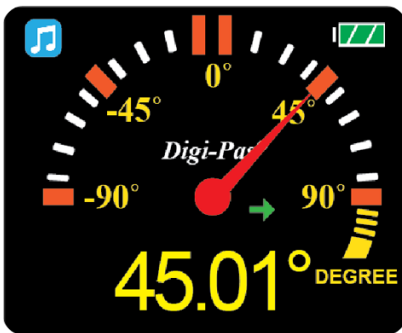

Place the digital level on the surface to be measured.



Please ensure the contact surfaces of the device and measuring plane are clean and free from dust particles.



The green arrow sign on display indicates the higher side.

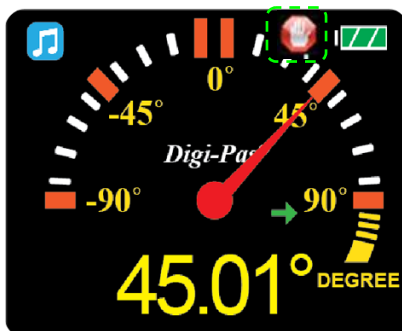

User may “freeze” the screen by pressing the HOLD button.



The icon pops up to indicate the screen is paused. To resume operation, press the hold button once.

Dual-Axis Mode Interface



Dual-Axis Mode Display Screen and Button Function

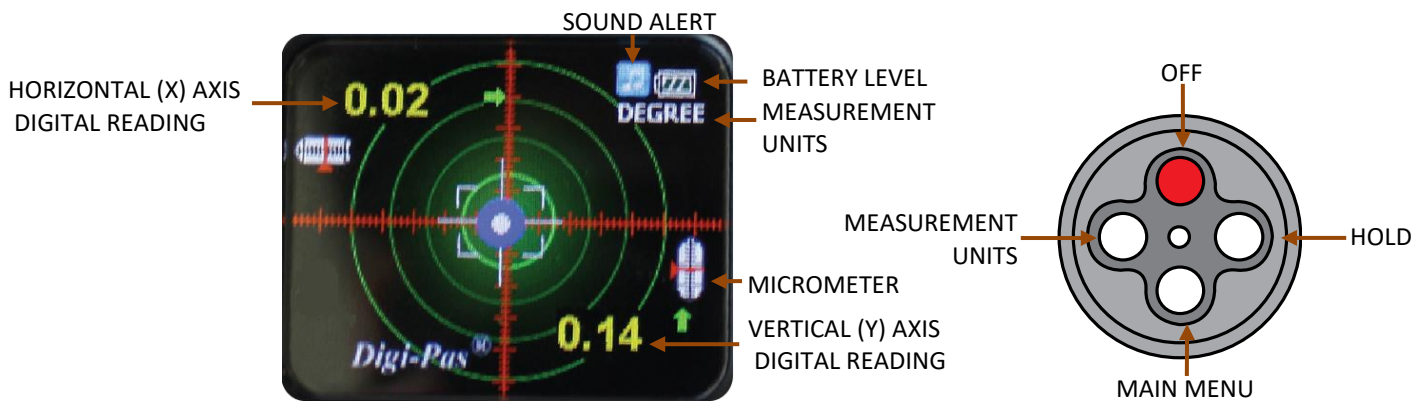

Dual-Axis Mode Operation



Place the digital level on the surface to be measured.



Please ensure the contact surfaces of the device and measuring plane are clean and free from dust particles.



The “Target Ball” or “Bull Eye” move towards the measured position similar to traditional "Bubble" vials. The green arrow sign on display indicates the higher side of plane.



Once the measurement stabilizes, the “Target Ball” or “Bull Eye” blinks.

Main Menu Icon Screen Display and Button Function

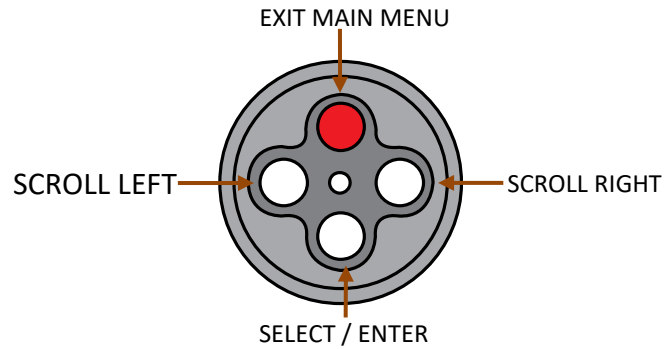

Main Menu Icon Features



ABSOLUTE LEVEL SETTING

Enable user to ensure each measurement reading is in accordance to maximum device accuracy specified.



ALTERNATE ZERO SETTING

Enable user to measure relative angles at a common plane with respect to a reference angle. Set any angle to 0.00° as a reference.



SETTING MENU

Enable user to modify various parameters of the device.



HELP MENU

Enable user to have a quick and easy reference on Device's button configuration.

CHAPTER 4: FEATURES AND SETTING



Absolute Level Screen Display and Button Function



Absolute Level Setting

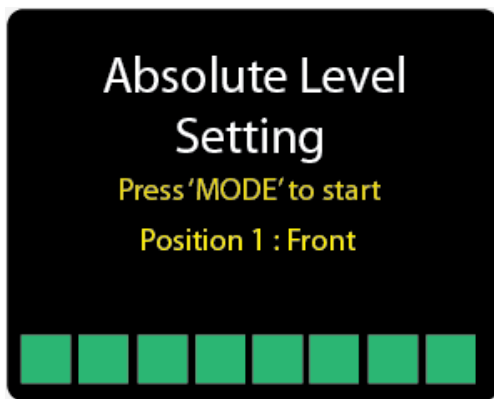

Place the device on the surface to be measured. Press MODE button to start the measurement and wait until the loading bar is full.





Please ensure the contact surfaces of the device and measuring plane are clean and free from dust particles.

Note: The device is able to auto detect its position is single axis position or dual-axis.

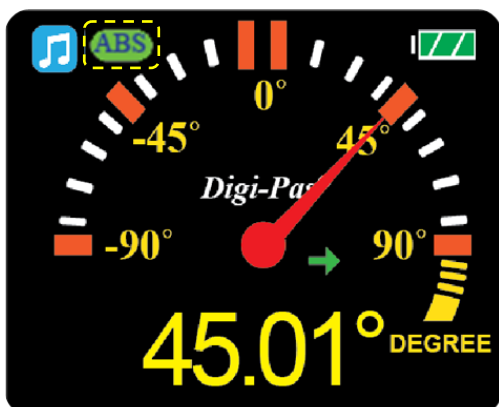

Turn the device 180° and press MODE button again to start the measurement.



When completed the above settings, the  logo is shown to indicate that the device is in the Absolute Level mode.



Alternate Zero Screen Display and Button Function

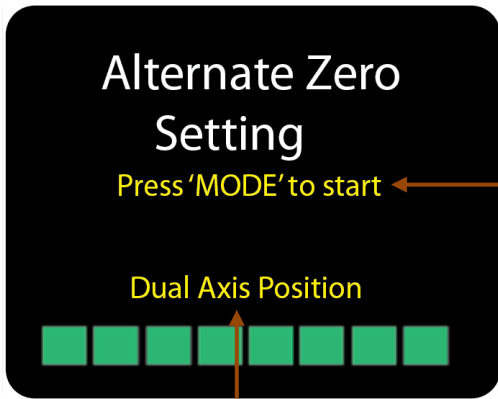

SINGLE OR Dual-AXIS INDICATOR

INSTRUCTION INDICATOR

MEASUREMENT UNIT

BACK TO MAIN MENU

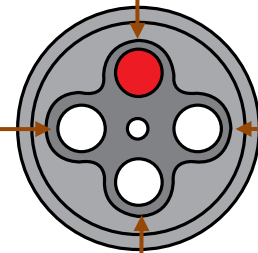

SELECT / ENTER

Alternate Zero Setting

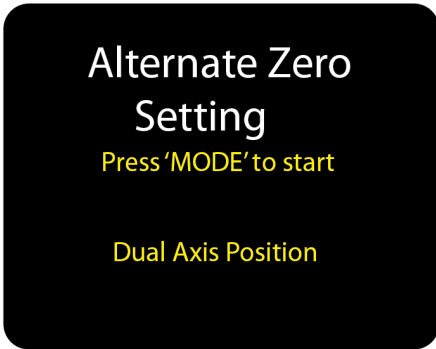

Place the digital level on the surface to be measured. Press MODE button to set the angle to 0° as a reference.



Please ensure the contact surfaces of the device and measuring plane are clean and free from dust particles.

Note: The device is able to auto detect its position is single axis position or 2-axis.

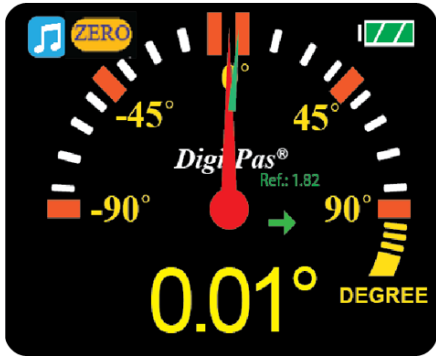

Single Axis Position

The **ZERO** logo is shown to indicate that the device is in Alternate Zero mode. A reference line is displayed to indicate the angle.



Dual Axis Position

The **ZERO** logo is shown to indicate the device is in the Alternate Zero mode. A reference crosshair is displayed to indicate the real angle.



Setting Menu Display Screen and Button Function

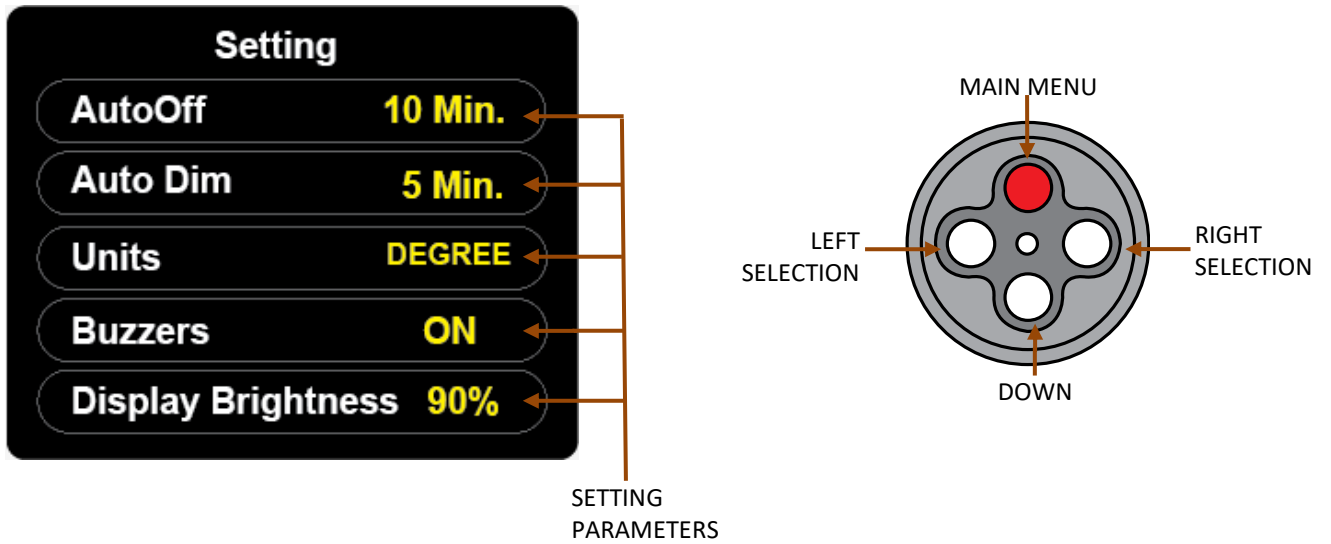

AutoOff	To set automatic power off according to user defined time period.
AutoDim	To set automatic dim according to user defined time period.
Units	To change the measuring unit (Degree, mm/M, In/FT).
Buzzer	To turn on/off the device buzzer.
Display Brightness	To set LCD brightness according to user defined level.

CHAPTER 5: STORAGE AND CLEANING

Storage

Keep the device in the equipment box and maintain the storage temperature within -20°C to 60°C or -4°F to 140°F .

When the device is not in used, the batteries are to be removed from the device.



Cleaning

1. Keep the device dry and clean. Remove any moisture or dirt with a soft dry cloth before measurement to obtain the maximum accuracy. Do not use harsh chemicals, strong detergents or cleaning solvent to clean the device.
2. Do not submerge device in liquid while cleaning.

CHAPTER 6: WARRANTY

Digi-Pas® 2-Axis High Precision Digital level is warranted to the original purchaser to be free from defects in workmanship and material. JSB Tech will, at its option, repair or replace any defective part which may malfunction under normal and proper use within a period of 2 (two) years from the date of purchase. The forgoing warranty shall not apply to defects resulting from misuse, abuse, assignment, or transfer by the Buyer. Buyer-supplied software or interfacing, unauthorized modification or operation outside of environment specifications for the product. JSB Tech does not warrant that the operation of instrument software, or firmware, will be uninterrupted or error free. The exclusive remedy under any and all warrants and guarantees, expressed herein, and we shall not be liable for damages from loss or delay of equipment uses, consequential, or incidental damage. No other Warranty is expressed or implied. JSB Tech specifically disclaims the implied warranties of merchantability and fitness for a particular purpose.

Limitation of Liability:

In no event shall DIGIPAS TECHNOLOGIE INC., (hereinafter, “the Company”) be liable to you or any third party for any indirect, special, incidental, exemplary or consequential damages of any kind resulting from any breach of warranty or from the performance or use of the product. This includes without limitation: property damage, loss of value of the product or any third party products that are used with the product, or loss of use of the product or any third party products that are used with the product, even if the Company has been advised of the possibility of such loss or damages. The Company’s total cumulative liability arising from or related to the product, whether in contract, tort (including negligence) or otherwise, shall not exceed the amount actually paid by you for the product. Some states and/or jurisdictions do not allow the exclusion or limitation of incidental or consequential damages, so the above limitations or exclusions may not apply to you. If any limitation of liability shall be deemed invalid by any applicable law, then the limitations of liability set forth above shall apply to the maximum extent permitted under applicable law.

Distributed by:

Manufactured by:

JSB TECH PTE LTD

Email:info@digipas.com

www.digipas.com

APPENDIX: USER CALIBRATION

Calibration Instruments:

Granite Table	Grade AA (Levelled to ≤ 1.0 arcsec.)
Master Square	Flatness : $\leq 2.0\mu\text{m}$
	Perpendicularity: $\leq 2.0\mu\text{m}$
	Parallelism: $\leq 2.0\mu\text{m}$

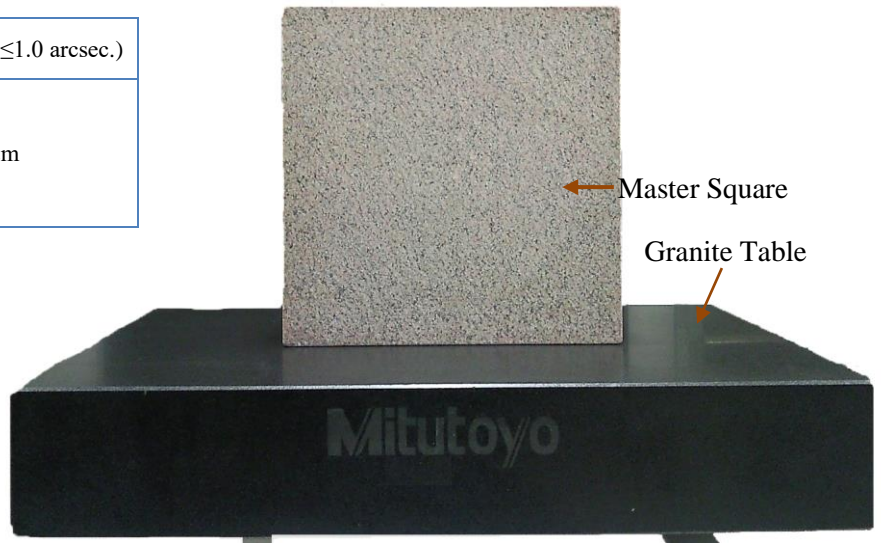

Calibration Procedures:



Ensure the DWL2000XY device is in power OFF condition. Press and hold the CAL button by using a small pin and simultaneously press the ON/OFF button. The LCD screen displays “Calibration 1”.



Position 1

1. Place the device to **Position 1**. Press the MODE button once and wait until the countdown reach “0”, the LCD screen displays “Calibration 2”.



Position 2

2. Turn the device 180° to **Position 2**. Press the MODE button again to start the calibration at “Position 2” and wait until the countdown reach “0”, the LCD screen displays “Calibration 3”.



Position 3

3. Place the device 90° on the side of Master Square as shown in **Position 3**. Hold the device firmly and do not move the device during each count down period. Press the MODE button again to start the calibration and wait until the countdown reach “0”, the LCD screen displays “Calibration 4”.



Position 4

4. Turn the device 180° and place on the opposite side of the master square as shown in **Position 4**. Hold the device firmly and do not move the device during each count down period. Press the MODE button again to start the calibration and wait until the countdown reach “0”, the LCD screen displays “Calibration 5” .



Position 5

5. Rotate the device 180° as shown **Position 5**. Hold the device firmly and do not move the device during each count down period. Press the MODE button again to start the calibration and wait until the countdown reach “0”, the LCD screen displays “Calibration 6” .



Position 6

6. Turn the device 180° and place on the opposite side of the master square as shown in **Position 6**. Hold the device firmly and do not move the device during each count down period. Press the MODE button again to start the calibration and wait until the countdown reach “0”, the LCD screen displays “Calibration 7”.



Position 7

7. Place the device to **Position 7**. Press the MODE button once and wait until the countdown reach “0”, the LCD screen displays “Calibration 8” .



Position 8

8. Turn the device 180° to **Position 8**. Press the MODE button again and wait until the countdown reach “0”, the LCD screen will switch to measuring mode once calibration is completed.

Precaution:

To achieve maximum accuracy, the device must be held firmly on to jig during calibration process. Any movement on countdown during each calibration procedure would affect device accuracy.